

®

# HEALTHRIDER

S O F T S T R I D E R

S300i

Model No. HCTL05910

Serial No. \_\_\_\_\_

Write the serial number in the space above for future reference.

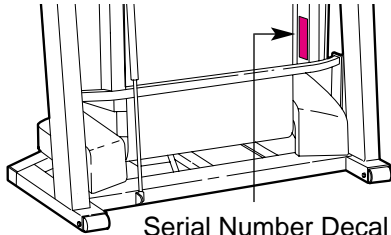

Serial Number Decal

## USER'S MANUAL

### QUESTIONS?

As a manufacturer, we are committed to providing complete customer satisfaction. If you have questions, or if there are missing parts, please call:

**1-888-936-4266**

Monday through Friday, 8h00 to 18h30 Eastern Standard Time (except holidays).

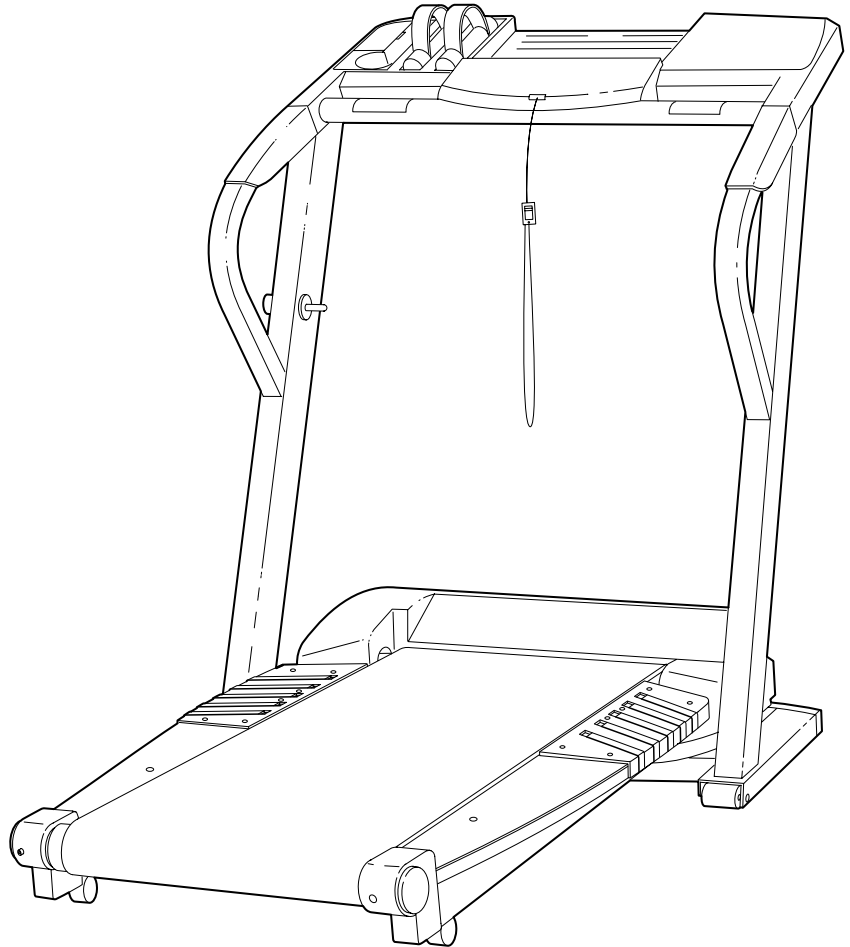

### ⚠ CAUTION

Read all precautions and instructions in this manual before using this equipment. Save this manual for future reference.



Visit our website at

[www.healthrider.com](http://www.healthrider.com)



---

## TABLE OF CONTENTS

IMPORTANT PRECAUTIONS .....	.3
BEFORE YOU BEGIN .....	.5
ASSEMBLY .....	.6
OPERATION AND ADJUSTMENT .....	.7
HOW TO FOLD AND MOVE THE TREADMILL .....	.21
TROUBLE-SHOOTING AND MAINTENANCE .....	.22
CONDITIONING GUIDELINES .....	.24
PART LIST .....	.26
HOW TO ORDER REPLACEMENT PARTS .....	.Back Cover
LIMITED WARRANTY .....	.Back Cover

Note: An EXPLODED DRAWING is attached in the center of this manual. Please save the EXPLODED DRAWING for future reference.

# IMPORTANT PRECAUTIONS

**⚠ WARNING:** To reduce the risk of burns, fire, electric shock, or injury to persons, read the following important precautions and information before operating the treadmill.

1. It is the responsibility of the owner to ensure that all users of this treadmill are adequately informed of all warnings and precautions.
2. Use the treadmill only as described in this manual.
3. Place the treadmill on a level surface, with 2 m (8 ft.) of clearance behind it. Do not place the treadmill on any surface that blocks air openings. To protect the floor or carpet from damage, place a mat under the treadmill.
4. Keep the treadmill indoors, away from moisture and dust. Do not put the treadmill in a garage or covered patio, or near water.
5. Do not operate the treadmill where aerosol products are used or where oxygen is being administered.
6. Keep children under the age of 12 and pets away from the treadmill at all times.
7. The treadmill should not be used by persons weighing more than 115 kg (250 lbs.).
8. Never allow more than one person on the treadmill at a time.
9. Wear appropriate exercise clothing when using the treadmill. Do not wear loose clothing that could become caught in the treadmill. Athletic support clothes are recommended for both men and women. *Always wear athletic shoes. Never use the treadmill with bare feet, wearing only stockings, or in sandals.*
10. When connecting the power cord (see page 7), plug the power cord into a surge protector (not included) and plug the surge protector into a grounded circuit capable of carrying 15 or more amps. No other appliance should be on the same circuit. Do not use an extension cord.
11. Use only a CUL-listed surge protector, rated at 15 amps, with a 14-gauge cord of 1,5 m (5 ft.) or less in length. Do not use an extension cord.
12. Keep the power cord and the surge suppressor away from heated surfaces.
13. Never move the walking belt while the power is turned off. Do not operate the treadmill if the power cord or plug is damaged, or if the treadmill is not working properly. (See **BEFORE YOU BEGIN** on page 5 if the treadmill is not working properly.)
14. Never start the treadmill while you are standing on the walking belt. Always hold the handrails while using the treadmill.
15. The treadmill is capable of high speeds. Adjust the speed in small increments to avoid sudden jumps in speed.
16. Using hand weights and not holding the handrails may compromise your ability to maintain your balance. Exercises using hand weights should be attempted only by experienced users.
17. The pulse sensor is not a medical device. Various factors, including the user's movement, may affect the accuracy of heart rate readings. The pulse sensor is intended only as an exercise aid in determining heart rate trends in general.
18. Never leave the treadmill unattended while it is running. Always remove the key, unplug the power cord and move the on/off switch to the off position when the treadmill is not in use. (See the drawing on page 5 for the location of the on/off switch.)
19. Do not attempt to raise, lower, or move the treadmill until it is properly assembled. (See **ASSEMBLY** on page 6, and **HOW TO FOLD AND MOVE THE TREADMILL** on page 21.) You must be able to safely lift 20 kg (45 lbs.) to raise, lower, or move the treadmill.
20. When folding or moving the treadmill, make sure that the storage latch is fully closed.

21. When using iFIT.com CD's and videos, an electronic "chirping" sound will alert you when the speed and/or incline of the treadmill is about to change. Always listen for the "chirp" and be prepared for speed and/or incline changes. In some instances, the speed and/or incline may change before the personal trainer describes the change.

22. When using iFIT.com CD's and videos, you can manually override the speed and incline settings at any time by pressing the speed and incline buttons. However, when the next "chirp" is heard, the speed and/or incline will change to the next settings of the CD or video program.

23. Always remove iFIT.com CD's and videos from your CD player or VCR when you are not using them.

24. Inspect and tighten all parts of the treadmill regularly.

25. Never insert or drop any object into any opening.

26. **DANGER:** Always unplug the power cord immediately after use, before cleaning the treadmill, and before performing the maintenance and adjustment procedures described in this manual. Never remove the motor hood unless instructed to do so by an authorized service representative. Servicing other than the procedures in this manual should be performed by an authorized service representative only.

27. This treadmill is intended for in-home use only. Do not use this treadmill in any commercial, rental, or institutional setting.

**⚠ WARNING:** Before beginning this or any exercise program, consult your physician. This is especially important for persons over the age of 35 or persons with pre-existing health problems. Read all instructions before using. ICON assumes no responsibility for personal injury or property damage sustained by or through the use of this product.

## SAVE THESE INSTRUCTIONS

The decals shown below have been placed on your treadmill. If a decal is missing, or if it is not legible, please call our Customer Service Department toll-free at 1-888-936-4266 to order a free replacement decal. Apply the decal in the location shown. Note: The large decal is shown at 38% of actual size.

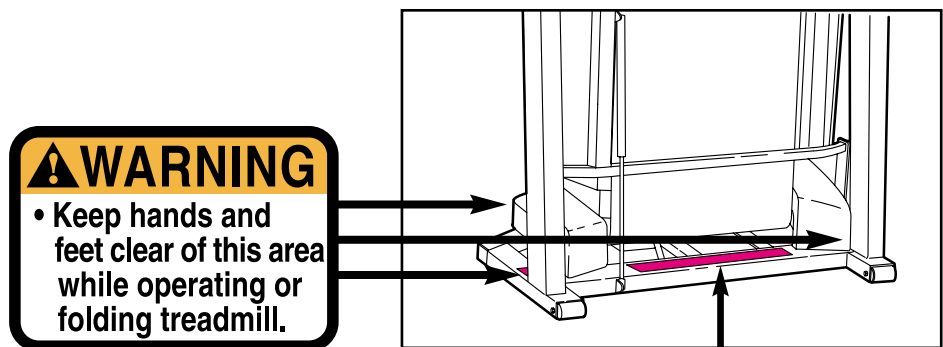

**⚠ WARNING:** Protect yourself and others from risk of serious injury. Read the user's manual and:

- Fully engage storage latch before treadmill is moved or stored.
- Reduce incline to lowest level before folding treadmill into storage position.
- Stand only on side rails when starting or stopping treadmill.
- Change speed in small increments.
- Hold handrails to prevent falling, and always wear the safety clip while operating treadmill.
- Stop if you feel faint, dizzy, or short of breath.
- Never allow children on or around treadmill.
- Remove key when not in use.
- Keep clothing, fingers, and hair away from moving belt.
- Never try to adjust or fix the belt while it is moving.
- Always wear athletic shoes while operating treadmill.





# BEFORE YOU BEGIN

Congratulations for purchasing the Softstrider S300i™ treadmill by HealthRider®. The S300i offers an impressive array of features to help you achieve your fitness goals in the convenience of your home. From the advanced console to the cushioned walking platform, the S300i is designed to make each workout more effective and enjoyable. And when you're not exercising, the S300i can be folded away, taking less than half the floor space of conventional treadmills.

questions, please call our Customer Service Department toll-free at 1-888-936-4266, Monday through Friday, 8h00 to 18h30 Eastern Standard Time (excluding holidays). To help us assist you, please note the product model number and serial number before calling. The model number is HCTL05910. The serial number can be found on a decal attached to the treadmill (see the front cover of this manual for the location).

**For your benefit, read this manual carefully before using the S300i treadmill.** If you have additional

Before reading further, please familiarize yourself with the parts that are labeled in the drawing below.

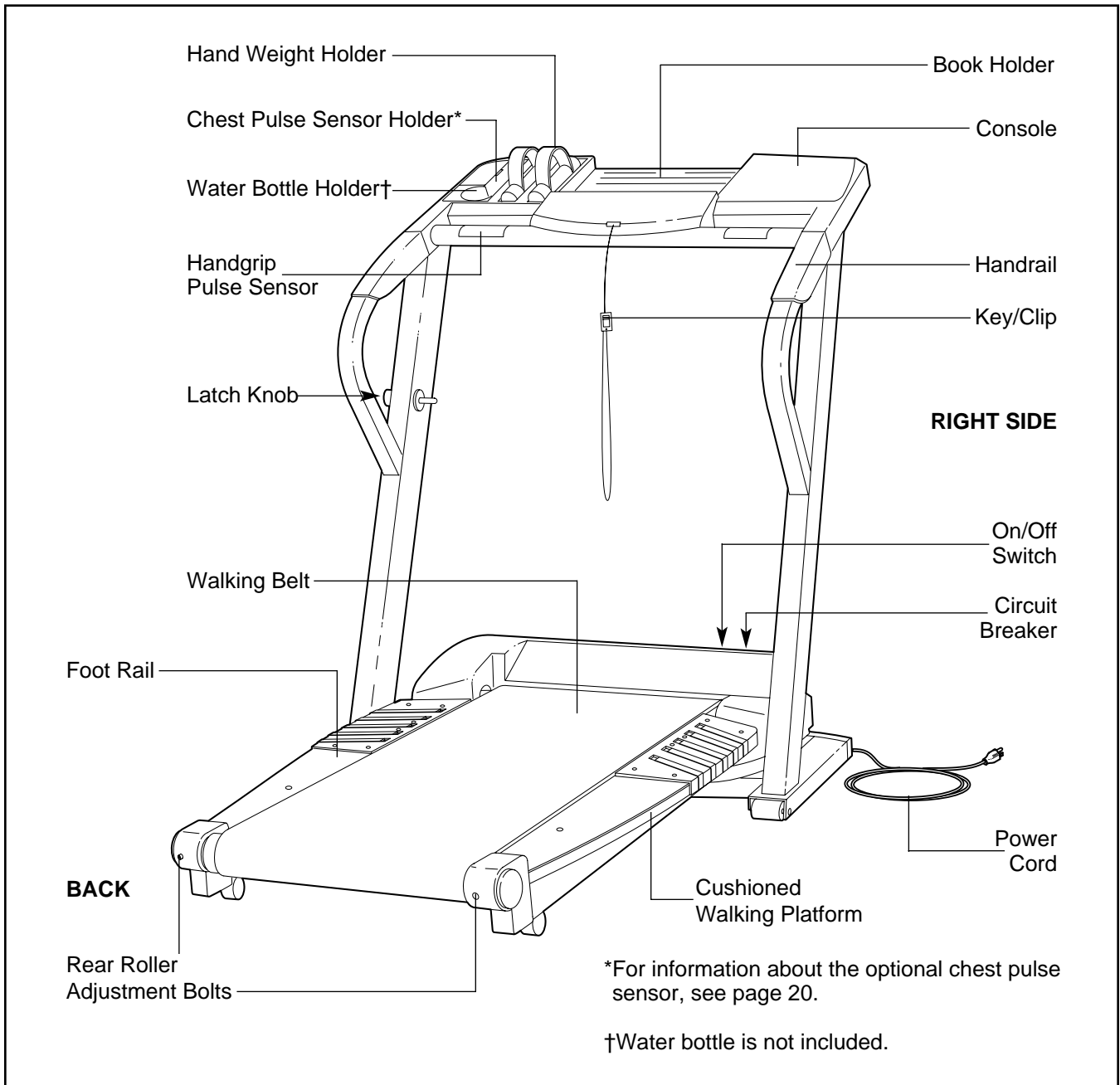

\*For information about the optional chest pulse sensor, see page 20.

†Water bottle is not included.

# ASSEMBLY

**Assembly requires two people.** Place the treadmill in a cleared area and remove all packing materials. Do not dispose of the packing materials until the treadmill is assembled. **No tools are required.**

Note: The underside of the treadmill walking belt is coated with high-performance lubricant. During shipping, a small amount of lubricant may be transferred to the top of the walking belt, the sides of the walking platform, or the shipping carton. This does not affect treadmill performance. If there is lubricant on top of the walking belt or on the sides of the walking platform, wipe off the lubricant with a soft cloth and a mild, non-abrasive cleaner.

1. **With the help of a second person,** carefully raise the Uprights (103) until the Wheels (99) are resting on the floor as shown.

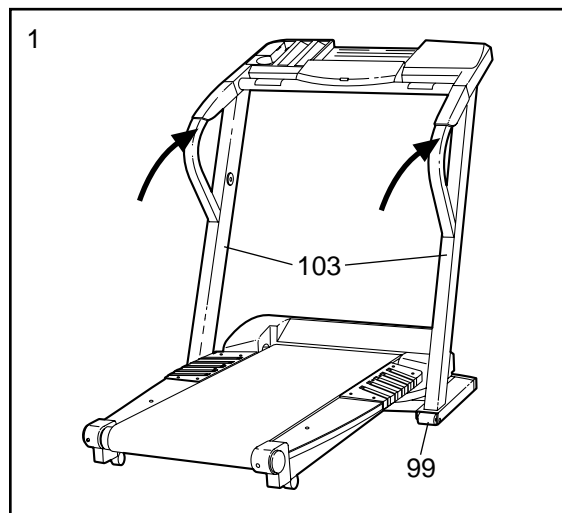

2. Next, make sure that the Latch Knob Sleeve (68) is fully inserted into the left Upright (103).

Remove the Latch Knob (67) from the Latch Pin (72). Make sure that the Latch Knob Collar (70) and the Spring (69) are on the Latch Pin. (Note: If there are two Latch Pin Collars, place one on each side of the Spring.) Insert the Latch Pin into the left Upright (103) and tighten the Latch Knob onto it.

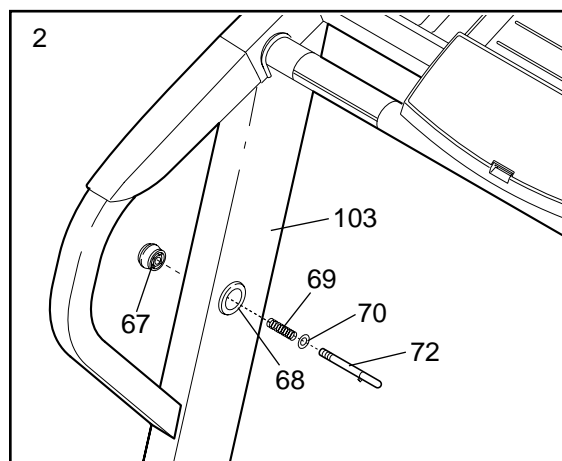

3. **Make sure that all parts are tightened before you use the treadmill. Place a mat beneath the treadmill to protect the floor or carpet.** For your benefit, we recommend that you familiarize yourself with the TROUBLE-SHOOTING AND MAINTENANCE section on pages 22 and 23.

# OPERATION AND ADJUSTMENT

## THE PERFORMANT LUBE™ WALKING BELT

Your treadmill features a walking belt coated with PERFORMANT LUBE™, a high-performance lubricant. **IMPORTANT: Never apply silicone spray or other substances to the walking belt or the walking platform. They will deteriorate the walking belt and cause excessive wear.**

## HOW TO PLUG IN THE POWER CORD

**⚠ DANGER:** Improper connection of the equipment-grounding conductor can result in an increased risk of electric shock. Check with a qualified electrician or serviceman if you are in doubt as to whether the product is properly grounded. Do not modify the plug provided with the product—if it will not fit the outlet, have a proper outlet installed by a qualified electrician.

Your treadmill, like any other type of sophisticated electronic equipment, can be seriously damaged by sudden voltage changes in your home's power. Voltage surges, spikes, and noise interference can result from weather conditions or from other appliances being turned on or off.

**To decrease the possibility of your treadmill being damaged, always use a surge protector (not included) with your treadmill.**

Surge protectors are sold at most hardware stores and department stores. Use only a UL-listed surge protector, rated at 15 amps, with a 14-gauge cord of five feet or less in length.

**This product must be grounded.** If it should malfunction or break down, grounding provides a path of least resistance for electric current to reduce the risk of

electric shock. This product is equipped with a cord having an equipment-grounding conductor and a grounding plug. **Plug the power cord into a surge protector, and plug the surge protector into an appropriate outlet that is properly installed and grounded in accordance with all local codes and ordinances. Important: The treadmill is not compatible with GFCI-equipped outlets.**

This product is for use on a nominal 120-volt circuit, and has a grounding plug that looks like the plug illustrated in drawing 1 below. A temporary adapter that looks like the adapter illustrated in drawing 2 may be used to connect the surge protector to a 2-pole receptacle as shown in drawing 2 if a properly grounded outlet is not available.

The temporary adapter should be used only until a properly grounded outlet (drawing 1) can be installed by a qualified electrician.

The green-colored rigid ear, lug, or the like extending from the adapter must be connected to a permanent ground such as a properly grounded outlet box cover. Whenever the adapter is used it must be held in place by a metal screw. **Some 2-pole receptacle outlet box covers are not grounded. Contact a qualified electrician to determine if the outlet box cover is grounded before using an adapter.**

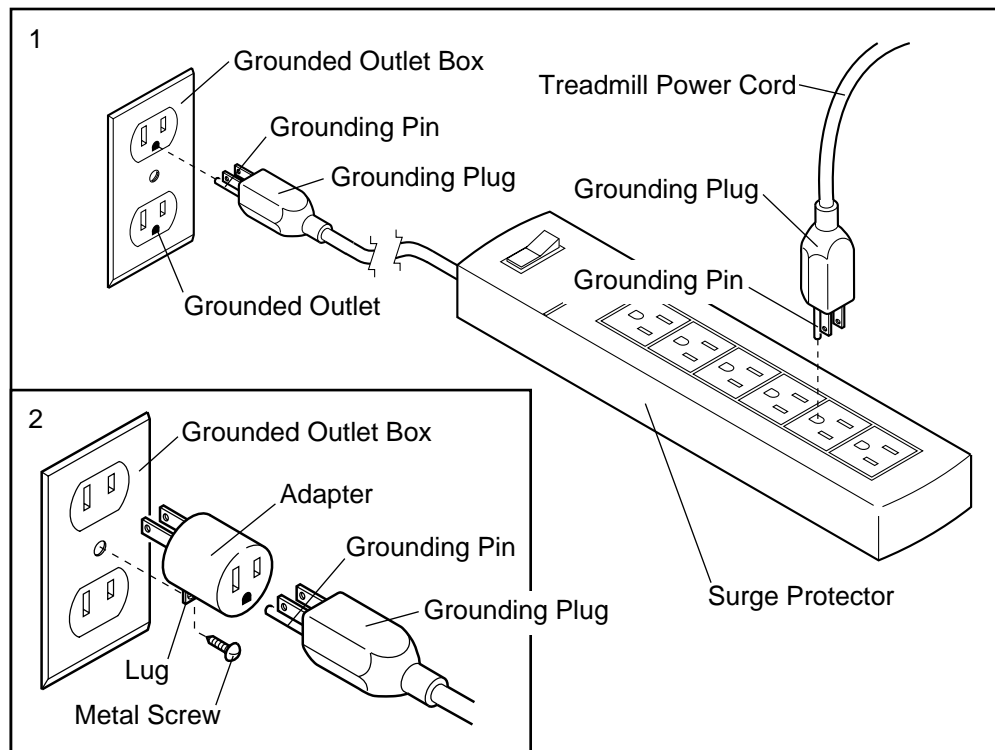

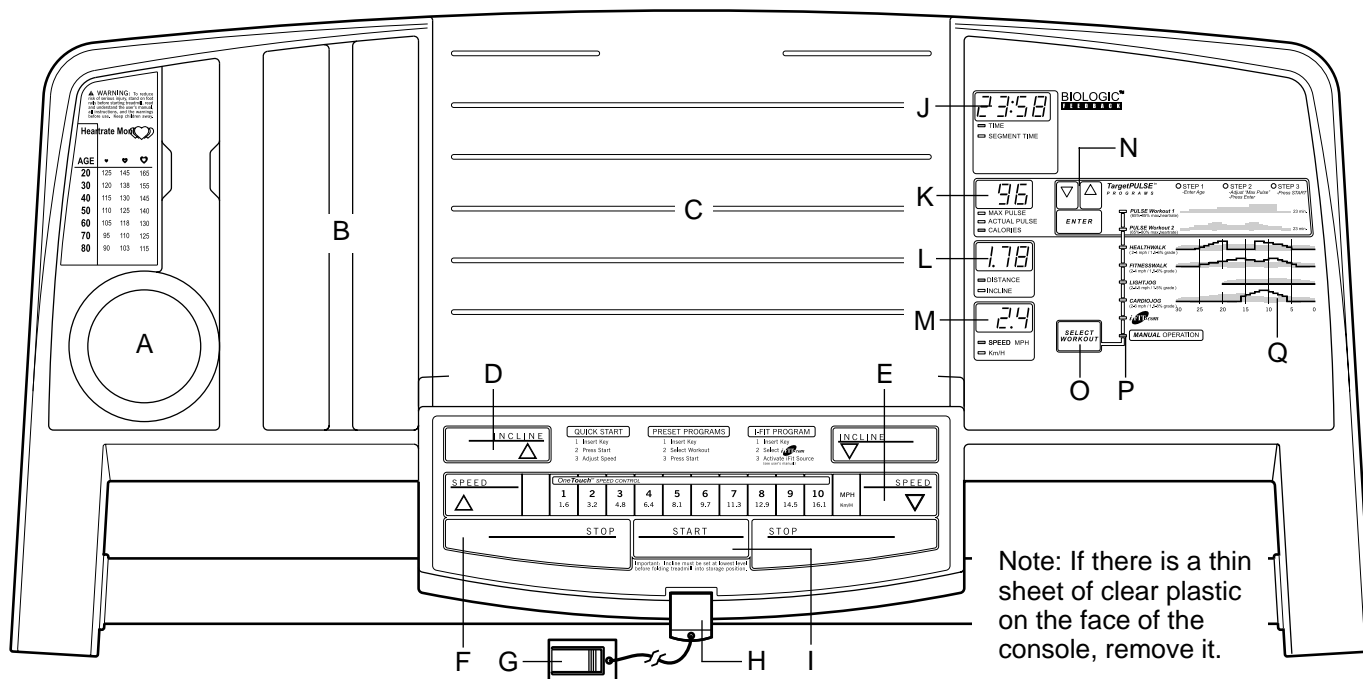

## FEATURES OF THE CONSOLE

The treadmill console offers an impressive selection of features to help you get the most from your exercise.

When the console is in the manual mode, the speed and incline of the treadmill can be changed with a touch of a button. As you exercise, the four displays will show your workout time, the number of calories you have burned, the distance you have walked, the incline level of the treadmill, and the speed of the walking belt. The console will also show your heart rate when the handgrip pulse sensor or the optional chest pulse sensor is used.

The console also offers four preset workout programs. Each program automatically controls the speed and incline of the treadmill as it guides you through an effective workout. If you purchase the optional chest pulse sensor, the console's two pulse programs can also be used. Each program controls the speed and incline of the treadmill to keep your heart rate within a preset range during your workouts.

The console also features advanced iFIT.com technology. iFIT.com technology is like having a personal trainer right in your home. Using the included audio cable, you can connect the treadmill to your home stereo, portable stereo, or computer and play special iFIT.com CD programs (one CD is included). iFIT.com CD programs automatically control the speed and incline of the treadmill as a personal trainer guides you

through every step of your workout. High-energy music provides added motivation. Each CD features two programs designed by certified personal trainers.

In addition, you can connect the treadmill to your VCR and TV and play iFIT.com video programs (one videocassette is included). Video programs offer the same benefits as iFIT.com CD programs, but add the excitement of working out with a class and an instructor—the hottest new trend at health clubs.

With the treadmill connected to your computer, you can also go to our new internet site at [www.iFIT.com](http://www.iFIT.com) and access basic programs that interactively control the speed and incline of your treadmill to help you achieve your specific exercise goals. Or, use iFIT.com audio and video programs directly from our internet site. Visit [www.iFIT.com](http://www.iFIT.com) for more information.

See [www.iFIT.com](http://www.iFIT.com) to learn about other iFIT.com features. **To purchase iFIT.com CD's, iFIT.com videocassettes, call toll-free 1-888-936-4266. For information about the optional chest pulse sensor, see page 20.**

**To use the manual mode of the console, follow the steps beginning on page 10. To use a preset program, see page 12. To use a pulse program, see page 13. To use iFIT.com CD or video programs, see page 17. To use iFIT.com programs directly from our internet site, see page 19.**



## DESCRIPTION OF THE CONSOLE

Refer to the drawing on page 8 to identify the features described below.

- A. Water bottle holder—This holder keeps your water bottle handy during your workouts (no water bottle is included).
- B. Hand weight holder—These compartments hold the hand weights.
- C. Book holder—This holder allows you to read a book or enjoy your favorite magazine while you get in shape.
- D. Incline buttons—These buttons control the incline of the treadmill. The incline range is 1.5% to 10%.
- E. Speed buttons and One Touch Speed buttons—These buttons control the speed of the walking belt. The speed range is 0.5 mph to 10 mph.
- F. Stop buttons—These buttons are used to stop the walking belt. Note: Pressing either button will stop the walking belt.
- G. Waistband clip—This clip is designed to be worn on the waistband of your clothes. If the key is pulled from the console, the walking belt will automatically stop.
- H. Key—This key turns the console on and off.
- I. Start button—This button is used to start the walking belt.
- J. Time/Segment Time display—When the manual mode or the iFIT.com mode is selected, this display will show the elapsed time. When a preset program or a pulse program is selected, the display will show both the time remaining in the program and the time remaining in the current segment of the program. The display will alternate between one number and the other every seven seconds.
- K. Calories/Pulse display—This display shows the approximate number of calories you have burned. When the optional chest pulse sensor is worn, the display will also show your heart rate. The display will alternate between one number and the other every seven seconds. If the handgrip pulse sensor is used, the display will show your heart rate continuously while your hands are on the pulse sensor.
- L. Distance/Incline display—This display shows the distance you have walked and the incline level of the treadmill. The display will alternate between one number and the other every seven seconds. Note: Each time the Incline buttons are pressed, the display will change to show the incline setting.
- M. Speed display—This display shows the speed of the walking belt.
- N. Enter button and  $\Delta$  and  $\nabla$  buttons—These buttons are used to enter your age when pulse programs are used.
- O. Select Workout button—This button is used to select the manual mode, the four preset programs, the two pulse programs, and the iFIT.com mode. Note: If the walking belt is moving when the Select Workout button is pressed, the walking belt will slow to a stop and the displays will be reset.
- P. Mode indicators—These indicators show whether the manual mode, a preset program, a pulse program, or the iFIT.com mode is selected.
- Q. Program profiles—These profiles show how the target heart rate will change during pulse programs and how the speed and incline of the treadmill will change during preset programs.

**Note: The console can display exercise feedback in either miles or kilometers (see SPEED DISPLAY on page 11). For simplicity, all instructions in this section refer to miles.**

**⚠ WARNING:** To reduce the risk of serious injury, read the following precautions before operating the console.

- Do not stand on the walking belt when turning on the power or starting the walking belt.
- Always attach the clip to your waistband when using the treadmill.
- The treadmill is capable of high speeds. Adjust the speed in small increments.
- To reduce the risk of electric shock, keep liquids away from the console and place only a sealed water bottle in the console.

## HOW TO TURN ON THE POWER

### 1 Attach the clip to the waistband of your clothes.

Stand on the foot rails of the treadmill. Find the clip attached to the key, and slide the clip onto the waistband of your clothes. Next, insert the key fully into the console. **Test the clip by carefully taking a few steps backward until the key is pulled from the console. If the key is not pulled from the console, adjust the position of the clip as needed.** Then, remove the key from the console.

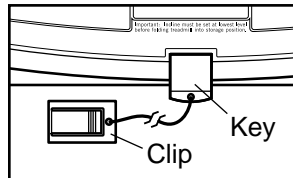

### 2 Plug in the power cord.

See page 7.

### 3 Move the on/off switch to the on position.

Locate the on/off switch on the treadmill near the power cord. Move the switch to the on position.

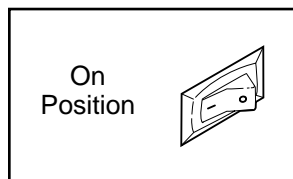

### 4 Insert the key fully into the console.

When the key is inserted, the four displays and various indicators on the console will light.

## HOW TO USE THE MANUAL MODE

### 1 Insert the key fully into the console.

See HOW TO TURN ON THE POWER at the left.

### 2 Select the manual mode.

When the key is inserted, the manual mode will be selected and the manual indicator will light. If a program has been selected, press the Select Workout button repeatedly to select the manual mode.

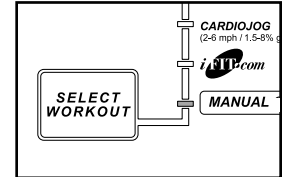

### 3 Press the Start button or the Speed $\Delta$ button to start the walking belt.

A moment after the button is pressed, the walking belt will begin to move at 1.0 mph. Hold the handrails and begin walking. As you exercise, adjust the speed of the walking belt as desired by pressing the Speed  $\Delta$  and  $\nabla$  buttons. Each time a button is pressed, the speed will change by 0.1 mph. If a button is held down, the speed will change in increments of 0.5 mph. To change the speed setting quickly, press the One Touch Speed buttons.

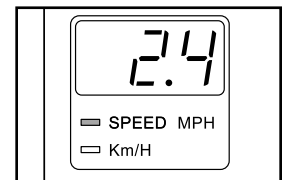

To stop the walking belt, press either of the Stop buttons. The four displays will pause and the Time/Segment Time display will begin to flash. To restart the walking belt, press the Start button or the Speed  $\Delta$  button. To stop the walking belt and reset the displays, press a Stop button, remove the key, and then reinsert the key.

### 4 Adjust the incline of the treadmill.

To vary the intensity of your exercise, adjust the incline of the treadmill as desired with the Incline buttons. Each time a button is pressed, the incline will change by 0.5%. The incline range is 1.5% to 10%. Note: After the buttons are pressed, it may take a moment for the treadmill to reach the selected incline setting.

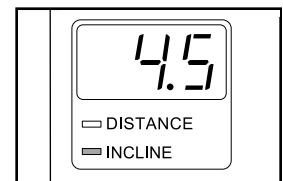

## 5 Follow your progress with the four displays.

### Time/Segment Time display

—When the manual mode or an iFIT.com program is selected, this display will show the elapsed time. When a preset program or a pulse program is selected, the display will show both the time remaining in the program and the time remaining in the current segment of the program. The display will alternate between one number and the other every seven seconds.

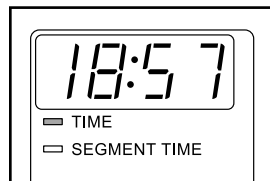

### Calories/Pulse display

—This display shows the approximate number of calories you have burned. When the optional chest pulse sensor is worn, the display will also show your heart rate. The display will alternate between one number and the other every seven seconds. If the handgrip pulse sensor is used, the display will show your heart rate continuously while your hands are on the pulse sensor.

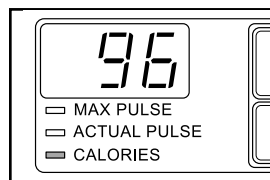

To use the handgrip pulse sensor, **stand on the foot rails** and place your hands on the metal contacts on the handrail. Your palms must be on the upper contacts, and your fingers must be touching the lower contacts—**avoid moving your hands**. After a few seconds, one or two dashes will appear in the Calories/Pulse display and then your heart rate will be shown. **For the most accurate heart rate reading, hold the contacts for about 15 seconds.**

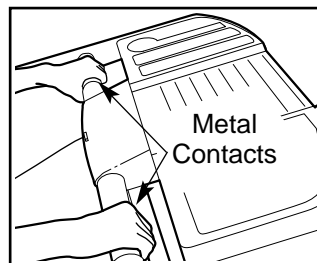

### Distance/Incline display

—This display shows the distance you have walked and the incline level of the treadmill. The display

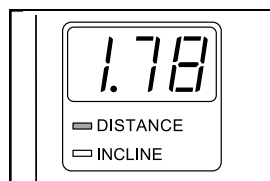

will alternate between one number and the other every seven seconds. Note: Each time the Incline buttons are pressed, the display will change to show the incline setting.

**Speed display**—This display shows the speed of the walking belt.

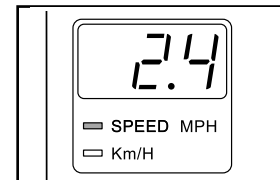

The console can display speed in either miles per hour or kilometers per hour. The MPH or Km/H indicator below the Speed display will light to show which unit of measurement is selected. To change the unit of measurement, first hold down one of the Stop buttons while inserting the key into the console. The Speed display will show an “E” for English miles or an “M” for metric kilometers. Press the Speed  $\Delta$  button to change the unit of measurement. When the desired unit of measurement is selected, remove and then reinsert the key. Note: If speed is shown in miles per hour, distance will be shown in miles; if speed is shown in kilometers per hour, distance will be shown in kilometers.

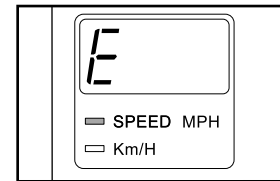

## 6 When you are finished exercising, stop the walking belt and remove the key.

Step onto the foot rails, press one of the Stop buttons, and adjust the incline of the treadmill to 1.5%. **The incline must be at 1.5% when the treadmill is raised to the storage position or the treadmill will be damaged.** Next, remove the key from the console and put it in a safe place. **Note: If the displays and indicators on the console remain lit after the key is removed, the console is in the “demo” mode. Refer to page 20 and turn off the demo mode.**

When you are finished using the treadmill, move the on/off switch near the power cord to the off position and unplug the power cord.

## THE PRESET PROGRAMS

### 1 Insert the key fully into the console.

See HOW TO TURN ON THE POWER on page 10.

### 2 Select one of the four preset programs.

When the key is inserted, the manual mode will be selected and the manual indicator will light. To select one of the preset programs, press the Select Workout button repeatedly until one of the four preset program indicators lights.

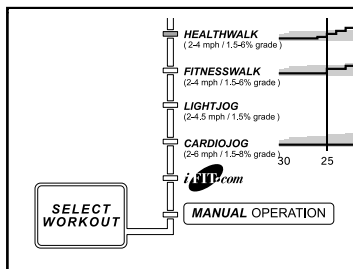

The profiles on the console show how the speed and incline of the treadmill will change during the preset programs—the white profiles show speed settings and the green lines show incline settings. The numbers at the left ends of the profiles show the speed and incline ranges for the programs. For example, during the HEALTHWALK program, the speed of the walking belt will be from 2 mph to 4 mph and the incline will be from 1.5% to 6%. The Time/Segment Time display will show how long the selected program will last.

### 3 Press the Start button or the Speed $\Delta$ button to start the program.

A moment after the button is pressed, the treadmill will automatically adjust to the first speed and incline settings for the program. Hold the handrails and begin walking.

Each program is divided into several time segments of different lengths. The Time/Segment Time display will show both the time

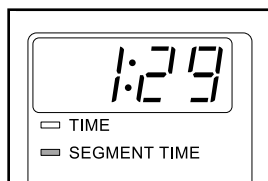

remaining in the program and the time remaining in the current segment. One speed setting and one incline setting are programmed for each segment. When only three seconds remain in the first segment of the program, a series of tones will sound and the treadmill will automatically adjust to the speed and incline settings for the second segment.

The program will continue in this way until the Time/Segment Time display counts down to zero. The walking belt will then slow to a stop.

If the speed or incline setting for the current segment is too high or too low, you can manually override the setting by pressing the Speed or Incline buttons on the console. **However, when the next segment begins, the treadmill will automatically adjust to the speed and incline settings for the next segment.**

To stop the program temporarily, press one of the Stop buttons. All displays will pause and the Time/Segment Time display will begin to flash. To restart the program, press the Start button or the Speed  $\Delta$  button. To end the program, press a Stop button, remove the key, and then reinsert the key.

### 4 Follow your progress with the four displays.

Refer to step 5 on page 11.

### 5 When the program has ended, remove the key.

Step onto the foot rails and make sure that the incline of the treadmill is at 1.5%. **The incline must be at 1.5% when the treadmill is raised to the storage position.** Next, remove the key from the console and put it in a safe place. **Note: If the displays and indicators on the console remain lit after the key is removed, the console is in the “demo” mode. Refer to page 20 and turn off the demo mode.**

When you are finished using the treadmill, move the on/off switch near the power cord to the off position and unplug the power cord.

## HOW TO USE THE PULSE PROGRAMS

**⚠ WARNING:** If you have heart problems, or if you are over 60 years of age and have been inactive, do not use the pulse programs. If you are taking medication regularly, consult your physician to find whether the medication will affect your exercise heart rate. *Note: The pulse programs require an optional chest pulse sensor.*

### 1 Insert the key fully into the console.

See HOW TO TURN ON THE POWER on page 10.

### 2 Put on the optional chest pulse sensor.

You must wear the optional chest pulse sensor in order to use a pulse program. To put on the chest pulse sensor, follow the instructions included with the chest pulse sensor.

### 3 Select one of the two pulse programs.

When the key is inserted, the manual mode will be selected and the manual indicator will light. To select one of the pulse programs, press the Select Workout button repeatedly until one of the two pulse program indicators lights.

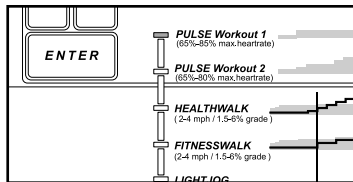

The profiles on the console show how the target heart rate will change during the programs. The Time/Segment Time display will show how long the selected program will last.

### 4 Enter your age.

When a pulse program is selected, an age setting will begin to flash in the Calories/Pulse display. If you have already entered your age, simply press the Enter button. To enter your age, press the  $\Delta$  and  $\nabla$  buttons. The buttons can be held down to enter your age quickly. When your age is shown, press the Enter button.

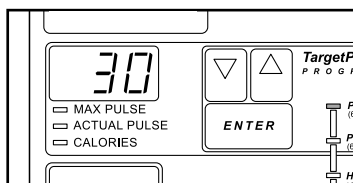

### 5 Enter a maximum heart rate setting.

After you have entered your age, another number will begin to flash in the Calories/Pulse display.

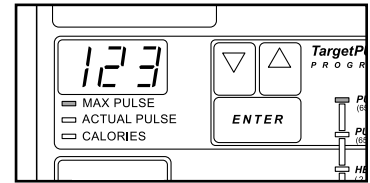

This number is the *maximum heart rate setting* for the program. If Pulse program 1 is selected, the maximum heart rate setting can be from 65% to 85% of your *maximum possible heart rate* (your maximum possible heart rate is 220 minus your age); if Pulse program 2 is selected, the maximum heart rate setting can be from 65% to 80% of your maximum possible heart rate. Note: Your maximum possible heart rate is an estimate only.

For example, if you are 30 years old, your maximum possible heart rate is 190 (220 minus 30 equals 190). Therefore, if Pulse program 1 is selected, the maximum heart rate setting can be from 123 to 161 (65% of 190 is 123; 85% of 190 is 161).

If you want to change the maximum heart rate setting, press the  $\Delta$  and  $\nabla$  buttons. The buttons can be held down to change the setting quickly. When the desired setting is shown, press the Enter button.

### 6 Press the Start button or the Speed $\Delta$ button to start the program.

A moment after the button is pressed, the treadmill will automatically adjust to the first speed and incline settings for the program. Hold the handrails and begin walking.

Each program is divided into several time segments of different lengths. The Time/Segment Time display will show both the time remaining in the program and the time remaining in the current segment.

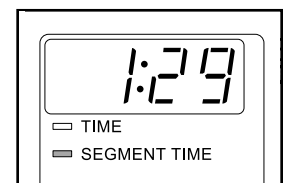

One target heart rate setting is programmed for each segment. When only three seconds remain in the first segment of the program, a series of tones will sound and the next segment will begin. As you exercise, the speed and/or incline of the treadmill will automatically change as needed to keep your heart rate near the current target heart rate setting.

The program will continue until the Time/Segment Time display counts down to zero. The walking belt will then slow to a stop.

If your heart rate is not detected during the program, the speed and incline of the treadmill may automatically decrease until your heart rate is detected. If this happens, see the instructions included with the chest pulse sensor.

If the speed or incline setting for the current segment is too high or too low, you can adjust the setting with the Speed or Incline buttons. However, if you *decrease* the speed, the incline will automatically *increase*; if you *increase* the speed, the incline will *decrease*. If you *increase* the incline, the speed will *decrease*; if you *decrease* the incline, the speed will *increase*. *The treadmill will always attempt to keep your heart rate near the target heart rate setting for the current segment.* Note: When the incline reaches the lowest setting, the speed cannot be increased any further. When the incline reaches the highest setting, the speed cannot be decreased any further.

Pulse programs should not be stopped temporarily and then restarted. To stop the program before it is completed, press a Stop button, remove the key, and then reinsert the key.

## **7 Follow your progress with the four displays.**

Refer to step 5 on page 11.

## **8 When the program has ended, remove the key.**

Step onto the foot rails and make sure that the incline of the treadmill is at 1.5%. **The incline must be at 1.5% when the treadmill is raised to the storage position.** Next, remove the key from the console and put it in a safe place. **Note: If the displays and indicators on the console remain lit after the key is removed, the console is in the “demo” mode. Refer to page 20 and turn off the demo mode.**

When you are finished using the treadmill, move the on/off switch near the power cord to the off position and unplug the power cord.

## HOW TO CONNECT THE TREADMILL TO YOUR CD PLAYER, VCR, OR COMPUTER

To use **iFIT.com CD's**, the treadmill must be connected to your portable CD player, portable stereo, home stereo, or computer with CD player. See pages 15 and 16 for connecting instructions. To use **iFIT.com videocassettes**, the treadmill must be connected to your VCR. See page 17 for connecting instructions. To use **iFIT.com programs directly from our internet site**, the treadmill must be connected to your home computer. See page 16 for connecting instructions.

## HOW TO CONNECT YOUR PORTABLE CD PLAYER

**Note:** If your CD player has separate **LINE OUT** and **PHONES** jacks, see instruction A below. If your CD player has only one jack, see instruction B.

- A. Plug one end of the audio cable into the jack on the front of the treadmill near the power cord. Plug the other end of the cable into the **LINE OUT** jack on your CD player. Plug your headphones into the **PHONES** jack.

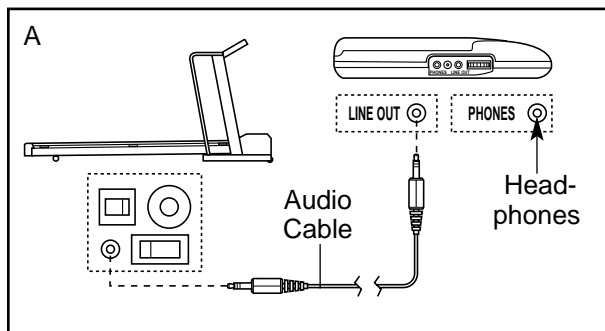

- B. Plug one end of the audio cable into the jack on the front of the treadmill near the power cord. Plug the other end of the cable into a 3.5mm Y-adaptor (available at electronics stores). Plug the Y-adaptor into the **PHONES** jack on your CD player. Plug your headphones into the other side of the Y-adaptor.

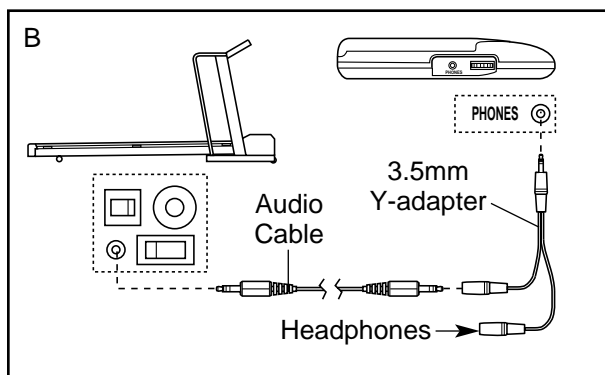

## HOW TO CONNECT YOUR PORTABLE STEREO

**Note:** If your stereo has an **RCA-type AUDIO OUT** jack, see instruction A below. If your stereo has a **3.5mm LINE OUT** jack, see instruction B. If your stereo has only a **PHONES** jack, see instruction C.

- A. Plug one end of the audio cable into the jack on the front of the treadmill near the power cord. Plug the other end of the cable into the included adapter. Plug the adapter into an **AUDIO OUT** jack on your stereo.

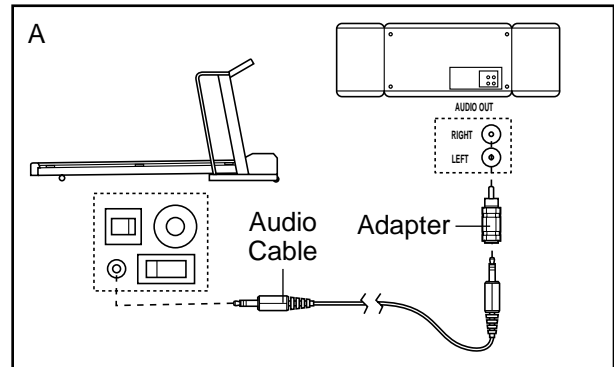

- B. Plug one end of the audio cable into the jack on the front of the treadmill near the power cord. Plug the other end of the cable into the **LINE OUT** jack on your stereo.

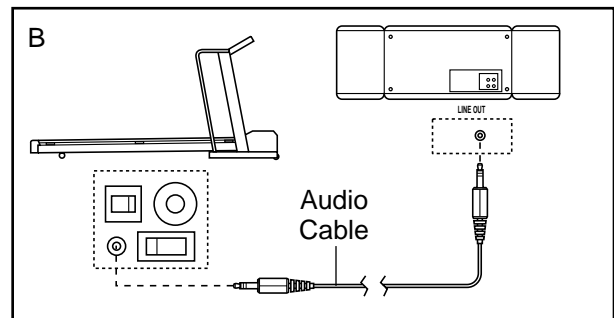

- C. Plug one end of the audio cable into the jack on the front of the treadmill near the power cord. Plug the other end of the cable into a 3.5mm Y-adaptor (available at electronics stores). Plug the Y-adaptor into the **PHONES** jack on your stereo. Plug your headphones into the other side of the Y-adaptor.

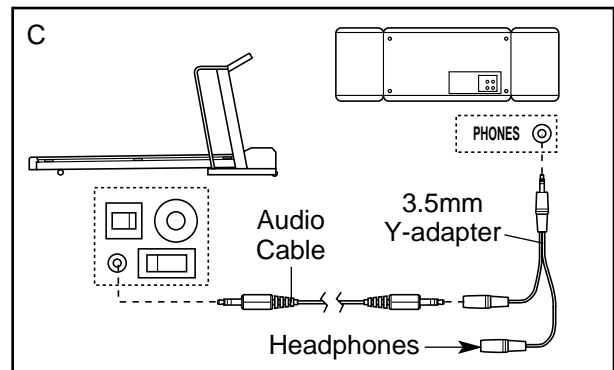

## HOW TO CONNECT YOUR HOME STEREO

**Note:** If your stereo has an unused **LINE OUT** jack, see instruction **A** below. If the **LINE OUT** jack is being used, see instruction **B**.

- A. Plug one end of the audio cable into the jack on the front of the treadmill near the power cord. Plug the other end of the cable into the included adapter. Plug the adapter into the **LINE OUT** jack on your stereo.

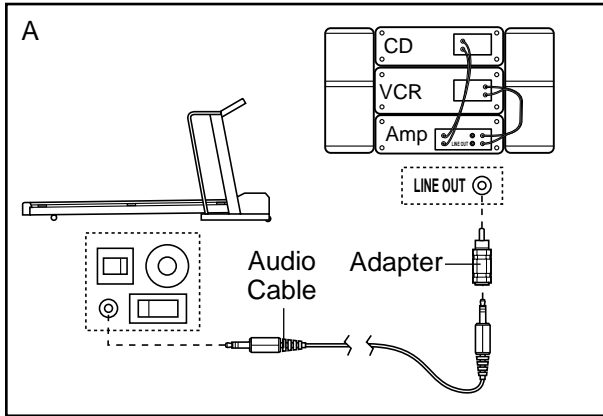

- B. Plug one end of the audio cable into the jack on the front of the treadmill near the power cord. Plug the other end of the cable into the included adapter. Plug the adapter into an **RCA Adapter** (available at electronics stores). Next, remove the wire that is currently plugged into the **LINE OUT** jack on your stereo and plug the wire into the unused side of the **RCA Adapter**. Plug the **RCA Adapter** into the **LINE OUT** jack on your stereo.

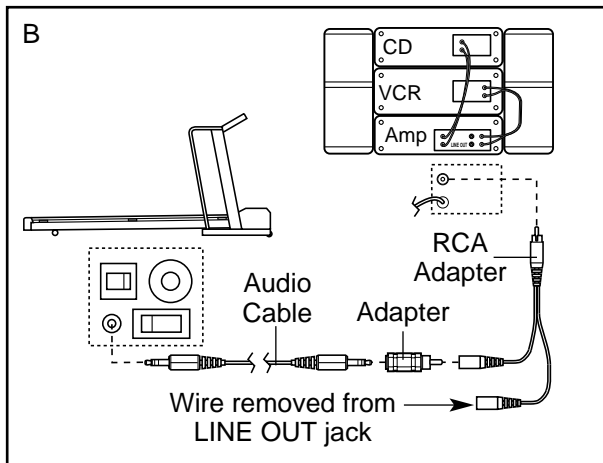

## HOW TO CONNECT YOUR COMPUTER

**Note:** If your computer has a **3.5mm LINE OUT** jack, see instruction **A**. If your computer has only a **PHONES** jack, see instruction **B**.

- A. Plug one end of the audio cable into the jack on the front of the treadmill near the power cord. Plug the other end of the cable into the **LINE OUT** jack on your computer.

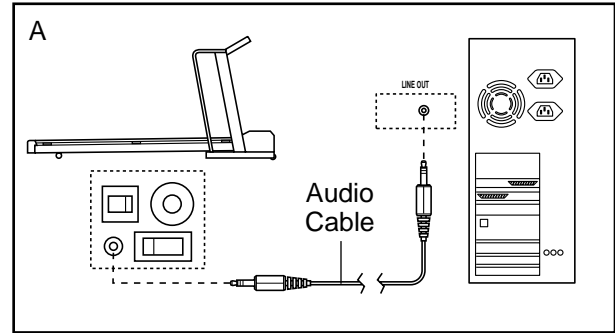

- B. Plug one end of the audio cable into the jack on the front of the treadmill near the power cord. Plug the other end of the cable into a **3.5mm Y-adapter** (available at electronics stores). Plug the **Y-adapter** into the **PHONES** jack on your computer. Plug your headphones or speakers into the other side of the **Y-adapter**.

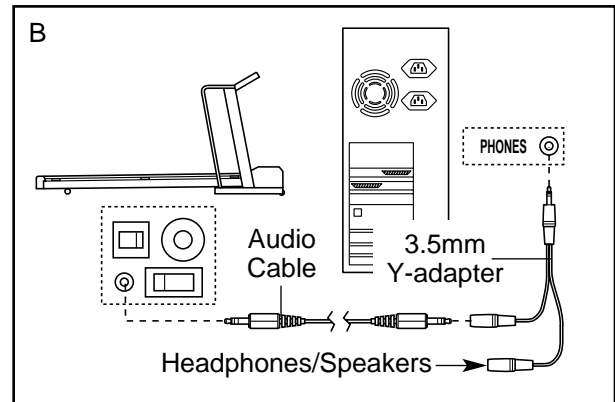



## HOW TO CONNECT YOUR VCR

**Note:** If your VCR has an unused AUDIO OUT jack, see instruction A below. If the AUDIO OUT jack is being used, see instruction B. If you have a TV with a built-in VCR, see instruction B. If your VCR is connected to your home stereo, see **HOW TO CONNECT YOUR HOME STEREO** on page 16.

- A. Plug one end of the audio cable into the jack on the front of the treadmill near the power cord. Plug the other end of the cable into the included adapter. Plug the adapter into the AUDIO OUT jack on your VCR.

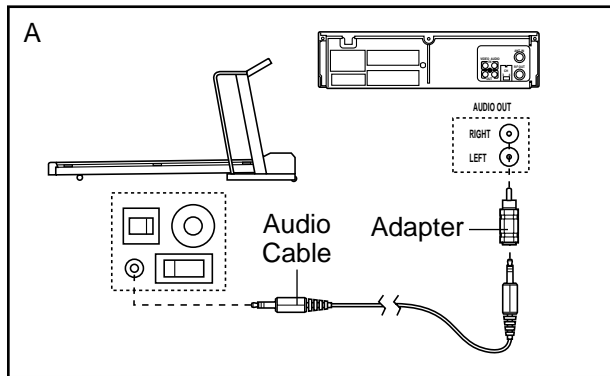

- B. Plug one end of the audio cable into the jack on the front of the treadmill near the power cord. Plug the other end of the cable into the included adapter. Plug the adapter into an RCA adapter (available at electronics stores). Next, remove the wire that is currently plugged into the AUDIO OUT jack on your VCR and plug the wire into the unused side of the RCA adapter. Plug the RCA adapter into the AUDIO OUT jack on your VCR.

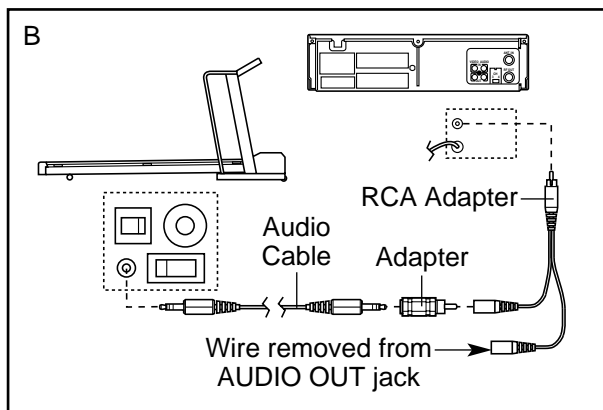

## HOW TO USE iFIT.COM CD AND VIDEO PROGRAMS

To use iFIT.com CD's or videocassettes, the treadmill must be connected to your portable CD player, portable stereo, home stereo, computer with CD player, or VCR. See **HOW TO CONNECT THE TREADMILL TO YOUR CD PLAYER, VCR, OR COMPUTER** on page 15. **One iFIT.com CD and one iFIT.com videocassette are included. To purchase other CD's or videocassettes, call toll-free 1-888-936-4266.**

Follow the steps below to use an iFIT.com CD or video program.

### 1 Insert the key fully into the console.

See **HOW TO TURN ON THE POWER** on page 10.

### 2 Select the iFIT.com mode.

When the key is inserted, the manual mode will be selected. To use iFIT.com CD's or videocassettes, press the Select Workout button repeatedly until the iFIT.com indicator lights.

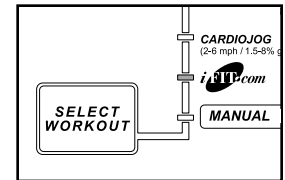

### 3 Insert the iFIT.com CD or videocassette.

If you are using an iFIT.com CD, insert it into your CD player. If you are using an iFIT.com videocassette, insert it into your VCR.

### 4 Press the PLAY button on your CD player or VCR.

A moment after the button is pressed, your personal trainer will begin guiding you through your workout. Simply follow your personal trainer's instructions. Note: If the Time/Segment Time display is flashing, press the Start button or the Speed  $\Delta$  button on the console. The treadmill will not respond to a CD or video program when the Time/Segment Time display is flashing.

During the CD or video program, an electronic "chirping" sound will alert you when the speed and/or incline of the treadmill is about to change. **CAUTION: Always listen for the "chirp" and be prepared for speed and/or incline changes. In some instances, the speed and/or incline may change before the personal trainer describes the change.**

If the speed or incline settings are too high or too low, you can manually override the settings at any time by pressing the Speed or Incline buttons on the console. However, **when the next “chirp” is heard, the speed and/or incline will change to the next settings of the CD or video program.**

To stop the walking belt at any time, press a Stop button on the console. The Time/Segment Time display will begin to flash. To restart the program, press the Start button. After a moment, the walking belt will begin to move at 1.0 mph. **When the next “chirp” is heard, the speed and incline will change to the next settings of the CD or video program.** The program can also be stopped by pressing the stop button on your CD player or VCR.

When the CD or video program is completed, the walking belt will stop and the Time/Segment Time display will begin to flash. Note: To use another CD or video program, press a Stop button or remove the key and go to step 1 on page 17.

**Note: If the speed or incline of the treadmill does not change when a “chirp” is heard:**

- **Make sure that the iFIT.com indicator is lit and that the Time/Segment Time display is not flashing. If the Time/Segment Time display is flashing, press the Start button or the Speed  $\Delta$  button on the console.**

- **Adjust the volume of your CD player or VCR. If the volume is too high or too low, the console may not detect the program signals.**
- **Make sure that the audio cable is properly connected, that it is fully plugged in, and that it is not wrapped around a power cord.**
- **If you are using your portable CD player and the CD skips, set the CD player on the floor or another flat surface instead of on the console.**

**5** Follow your progress with the four displays.

See step 5 on page 11.

**6** When the program is completed, remove the key.

See step 5 on page 12.

**CAUTION: Always remove iFIT.com CD's and videocassettes from your CD player or VCR when you are finished using them.**

## HOW TO USE PROGRAMS DIRECTLY FROM OUR INTERNET SITE

Our new internet site at [www.iFIT.com](http://www.iFIT.com) allows you to access a selection of programs that interactively control your treadmill to help you achieve your specific exercise goals. In addition, you can play iFIT.com audio and video programs directly from the internet.

To use programs from our internet site, the treadmill must be connected to your home computer. See HOW TO CONNECT YOUR COMPUTER on page 16. In addition, you must have an internet connection and an internet service provider. A list of specific system requirements will be found on our internet site.

Follow the steps below to use a program from our internet site.

### 1 Insert the key fully into the console.

See HOW TO TURN ON THE POWER on page 10.

### 2 Select the iFIT.com mode.

When the key is inserted, the manual mode will be selected and the manual indicator will light. To use a program from our internet site, press the Program Select button repeatedly until the iFIT.com indicator lights.

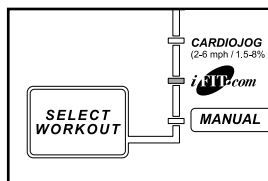

### 3 Go to your computer and start an internet connection.

### 4 Start your web browser, if necessary, and go to our internet site at [www.iFIT.com](http://www.iFIT.com).

### 5 Follow the desired links on our internet site to select a program.

Read and follow the on-line instructions for using a program.

### 6 Follow the on-line instructions to start the program.

When you start the program, an on-screen countdown will begin.

### 7 Return to the treadmill and stand on the foot rails. Find the clip attached to the key and slide the clip onto the waistband of your clothing.

When the on-screen countdown ends, the program will begin and the walking belt will begin to move. Hold the handrails, step onto the walking belt, and begin walking.

During the program, an electronic “chirping” sound will alert you when the speed and/or incline of the treadmill is about to change. **CAUTION: Always listen for the “chirp” and be prepared for speed and/or incline changes.**

If the speed or incline settings are too high or too low, you can manually override the settings at any time by pressing the Speed or Incline buttons on the console. **However, when the next “chirp” is heard, the speed and/or incline will change to the next settings of the program.**

To stop the walking belt at any time, press a Stop button on the console. The Time/Segment Time display will begin to flash. To restart the program, press the Start button. After a moment, the walking belt will begin to move at 1.0 mph. **When the next “chirp” is heard, the speed and incline will change to the next settings of the program.**

When the program is completed, the walking belt will stop and the Time/Segment Time display will begin to flash. Note: To use another program, press a Stop button and go to step 5.

**Note: If the speed or incline of the treadmill does not change when a “chirp” is heard, make sure that the iFIT.com indicator is lit and that the Time/Segment Time display is not flashing. In addition, make sure that the audio cable is properly connected, that it is fully plugged in, and that it is not wrapped around a power cord.**

### 8 Follow your progress with the four displays.

See step 5 on page 11.

### 9 When the program has ended, remove the key.

See step 5 on page 12.

## THE INFORMATION MODE/DEMO MODE

The console features an information mode that keeps track of the total number of hours that the treadmill has been operated and the total number of miles that the walking belt has moved. The information mode also allows you to switch the console from miles per hour to kilometers per hour. In addition, the information mode allows you to turn on and turn off the demo mode.

To select the information mode, hold down one of the Stop buttons while inserting the key into the console. When the information mode is selected, the following information will be shown:

The Time/Segment Time display will show the total number of hours that the treadmill has been used.

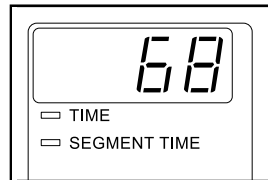

The Distance/Incline display will show the total number of miles that the walking belt has moved.

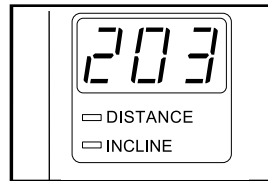

An "E," for English miles, or an "M," for metric kilometers, will appear in the Speed display. Press the Speed  $\Delta$  button to change the unit of measurement.

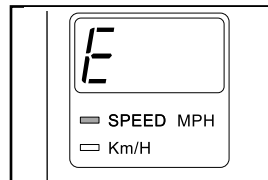

**IMPORTANT: The Calories/Pulse display should be blank.** If a "d" appears in the display, the console is in the "demo" mode. This mode is intended to be used only

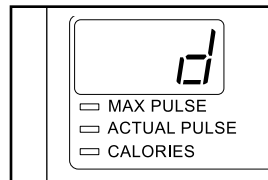

when a treadmill is displayed in a store. When the console is in the demo mode, the power cord can be plugged in, the key can be removed from the console, and the displays and indicators on the console will automatically light in a preset sequence, although the buttons on the console will not operate. **If a "d" appears in the Calories/Pulse display when the information mode is selected, press the Speed  $\nabla$  button so the Calories/Pulse display is blank.**

To exit the information mode, remove the key from the console.

## THE OPTIONAL CHEST PULSE SENSOR

An optional chest pulse sensor adds even more features to the console. The chest pulse sensor continuously monitors your heart rate during your workouts and allows you to use the console's two pulse programs. **To purchase the optional chest pulse sensor, call toll-free 1-888-936-4266.**

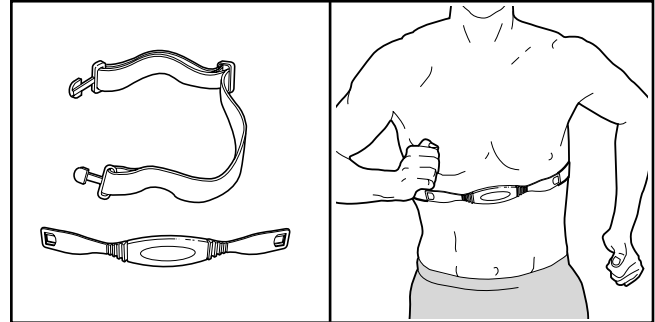

# HOW TO FOLD AND MOVE THE TREADMILL

## HOW TO FOLD THE TREADMILL FOR STORAGE

Before folding the treadmill, adjust the incline to the lowest position. If this is not done, the treadmill may be permanently damaged. Next, unplug the power cord. **Caution: You must be able to safely lift 20 kg (45 lbs.) in order to raise, lower, or move the treadmill.**

1. Hold the treadmill in the locations shown at the right. **To decrease the possibility of injury, bend your legs and keep your back straight. As you raise the treadmill, make sure to lift with your legs rather than your back.** Raise the treadmill about halfway to the vertical position.

2. Move your right hand to the position shown and hold the treadmill firmly. Using your left hand, pull the latch knob to the left and hold it. Raise the treadmill until all parts of the treadmill are past the latch pin. Release the latch knob. **Make sure that the latch knob is fully released so the latch pin is securely holding the catch.**

**To protect the floor or carpet from damage, place a mat under the treadmill. Keep the treadmill out of direct sunlight. Do not leave the treadmill in the storage position in temperatures above 30° C (85° F).**

## HOW TO MOVE THE TREADMILL

Before moving the treadmill, convert the treadmill to the storage position as described above. **Make sure that the latch pin is securely holding the catch.**

1. Hold the handrails and place one foot on the base.
2. Tilt the treadmill back until it rolls freely on the wheels. Carefully move the treadmill to the desired location. **To reduce the risk of injury, use extreme caution while moving the treadmill. Do not attempt to move the treadmill over an uneven surface.**
3. Place one foot on the base, and carefully lower the treadmill until it is resting in the storage position.

## HOW TO LOWER THE TREADMILL FOR USE

1. Hold the treadmill with your right hand as shown. Using your left hand, pull the latch knob to the left and hold it. Pivot the treadmill down until all parts of the treadmill are past the pin. Slowly release the latch knob.
2. See the drawing at the top of this page. Hold the treadmill firmly with both hands, and lower the treadmill to the floor. **To decrease the possibility of injury, bend your legs and keep your back straight.**

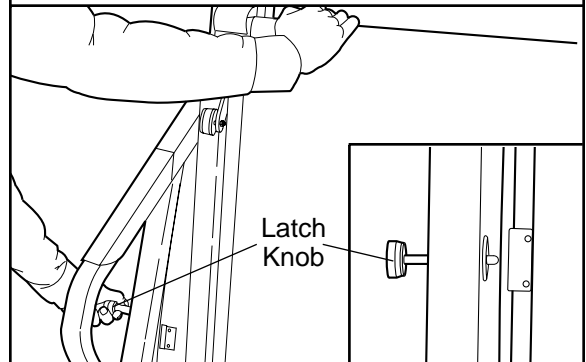
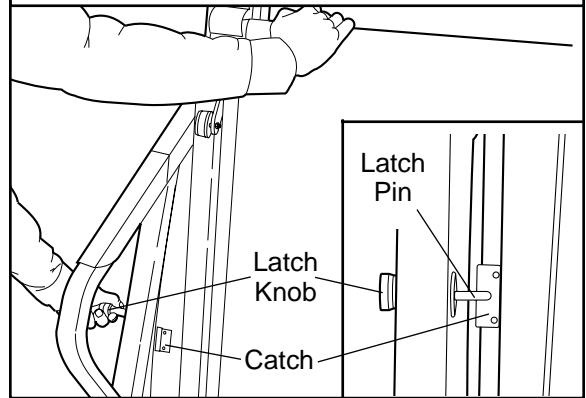
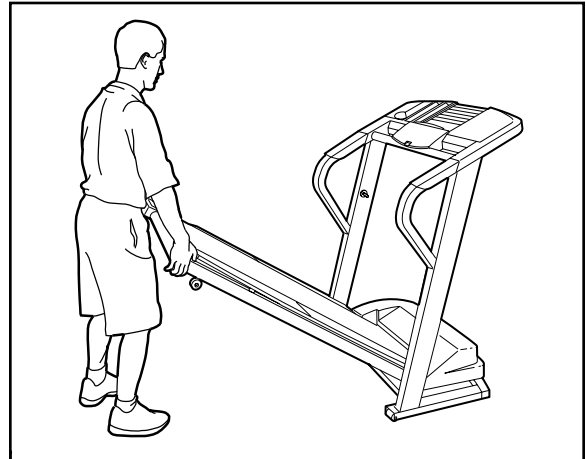

# TROUBLE-SHOOTING AND MAINTENANCE

Most treadmill problems can be solved by following the instructions below. If further assistance is needed, please call our Customer Service Department toll-free at 1-888-936-4266, Monday through Friday, 8h00 to 18h30, Eastern Standard Time (excluding holidays).

## PROBLEM

## SOLUTION

### 1. The power does not turn on

- a. Make sure that the power cord is plugged into a surge protector, and that the surge protector is plugged into a properly grounded outlet. (See HOW TO PLUG IN THE POWER CORD on page 7.) Use only a CUL-listed surge protector, rated at 15 amps, with a 14-gauge cord of 1,5 m (5 ft.) or less in length. Important: The treadmill is not compatible with GFCI-equipped outlets.

- b. After the power cord has been plugged in, make sure that the key is fully inserted into the console.

- c. Check the circuit breaker located on the treadmill near the power cord. If the switch protrudes as shown, the circuit breaker has tripped. To reset the circuit breaker, wait for five minutes and then press the switch back in.

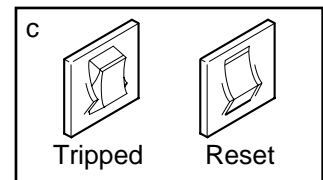

- d. Check the on/off switch located on the treadmill near the power cord. The switch must be in the on position.

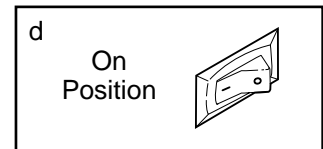

### 2. The power turns off during use

- a. Check the circuit breaker located on the treadmill frame near the power cord (see 1. c. above). If the circuit breaker has tripped, wait for five minutes and then press the switch back in.

- b. Make sure that the power cord is plugged in.

- c. Remove the key from the console and then reinsert it.

- d. Make sure that the on/off switch is in the on position (see 1. d. above).

### 3. The walking belt slows when walked on

- a. Make sure that only an appropriate surge suppressor is used (see 1. a. above).

- b. If the walking belt is overtightened, treadmill performance may decrease and the walking belt may become damaged. Remove the key and **UNPLUG THE POWER CORD**. Using the allen wrench, turn both rear roller adjustment bolts counterclockwise, 1/4 of a turn. When the walking belt is properly tightened, you should be able to lift each side of the walking belt 3 to 4 inches off the walking platform. Be careful to keep the walking belt centered. Plug in the power cord, insert the key and run the treadmill for a few minutes. Repeat until the walking belt is properly tightened.

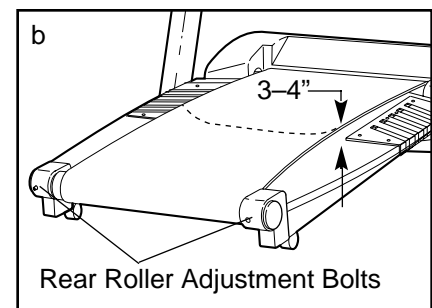

**PROBLEM****SOLUTION**

**4. The walking belt is off-center or slips when walked on**

a. Remove the key and **UNPLUG THE POWER CORD**. If the walking belt has **shifted to the left**, use the allen wrench to turn the left rear roller bolt clockwise 1/2 of a turn. Be careful not to overtighten the walking belt. If the walking belt has **shifted to the right**, turn the left rear roller bolt counterclockwise 1/2 of a turn. Plug in the power cord, insert the key and run the treadmill for a few minutes. Repeat until the walking belt is centered.

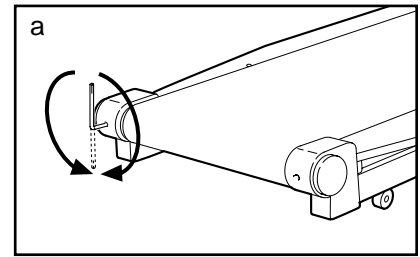

b. If the walking belt slips when walked on, first remove the key and **UNPLUG THE POWER CORD**. Using the allen wrench, turn both rear roller bolts clockwise 1/4 of a turn. When the walking belt is correctly tightened, you should be able to lift each side of the walking belt 3 to 4 inches off the walking platform. Be careful to keep the walking belt centered. Plug in the power cord, insert the key and carefully walk on the treadmill for a few minutes. Repeat until the walking belt is properly tightened.

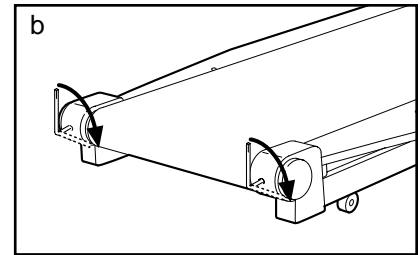

**5. The displays of the console do not function properly**

a. Remove the key from the console and **UNPLUG THE POWER CORD**. Next, remove the screws from the hood and carefully remove the hood. Locate the Reed Switch (26) and the Magnet (85) on the left side of the Pulley (11). Turn the Pulley until the Magnet is aligned with the Reed Switch. **Make sure that the gap between the Magnet and the Reed Switch is about 3mm (1/8")**. If necessary, loosen the Utility Screw (20) and move the Reed Switch slightly. Retighten the Screw. Re-attach the hood, and run the treadmill for a few minutes to check for a correct speed reading.

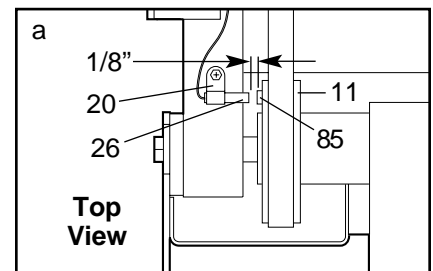

# CONDITIONING GUIDELINES

**⚠️ WARNING:** Before beginning this or any exercise program, consult your physician. This is especially important for individuals over the age of 35 or individuals with pre-existing health problems.

The pulse sensor is not a medical device. Various factors, including your movement, may affect the accuracy of heart rate readings. The sensor is intended only as an exercise aid in determining heart rate trends in general.

The following guidelines will help you to plan your exercise program. For more detailed exercise information, obtain a reputable book or consult your physician.

## EXERCISE INTENSITY

Whether your goal is to burn fat or to strengthen your cardiovascular system, the key to achieving the desired results is to exercise with the proper intensity. The proper intensity level can be found by using your heart rate as a guide. The chart below shows recommended heart rates for fat burning and aerobic exercise.

AEROBIC	165	155	145	140	130	125	115
MAX FAT BURN	145	138	130	125	118	110	103
FAT BURN	125	120	115	110	105	95	90
Age	20	30	40	50	60	70	80

To find the proper heart rate for you, first find your age near the bottom of the chart (ages are rounded off to the nearest ten years). Next, find the three numbers above your age. The three numbers define your “training zone.” The lower two numbers are recommended heart rates for fat burning; the higher number is the recommended heart rate for aerobic exercise.

## Fat Burning

To burn fat effectively, you must exercise at a relatively low intensity level for a sustained period of time. During the first few minutes of exercise, your body uses easily accessible *carbohydrate calories* for energy. Only after the first few minutes does your body begin to use stored *fat calories* for energy. If your goal

is to burn fat, adjust the speed and incline of the treadmill until your heart rate is near the lowest number in your training zone.

For maximum fat burning, adjust the speed and incline of the treadmill until your heart rate is near the middle number in your training zone.

## Aerobic Exercise

If your goal is to strengthen your cardiovascular system, your exercise must be “aerobic.” Aerobic exercise is activity that requires large amounts of oxygen for prolonged periods of time. This increases the demand on the heart to pump blood to the muscles, and on the lungs to oxygenate the blood. For aerobic exercise, adjust the speed and incline of the treadmill until your heart rate is near the highest number in your training zone.

## WORKOUT GUIDELINES

Each workout should include the following three parts:

**A Warm-up**—Start each workout with 5 to 10 minutes of stretching and light exercise. A proper warm-up increases your body temperature, heart rate and circulation in preparation for exercise.

**Training Zone Exercise**—After warming up, increase the intensity of your exercise until your pulse is in your training zone for 20 to 60 minutes. (During the first few weeks of your exercise program, do not keep your pulse in your training zone for longer than 20 minutes.) Breathe regularly and deeply as you exercise—never hold your breath.

**A Cool-down**—Finish each workout with 5 to 10 minutes of stretching to cool down. This will increase the flexibility of your muscles and will help prevent post-exercise problems.

## EXERCISE FREQUENCY

To maintain or improve your condition, complete three workouts each week, with at least one day of rest between workouts. After a few months, you may complete up to five workouts each week if desired.

The key to success is to make exercise a regular and enjoyable part of your everyday life.



## SUGGESTED STRETCHES

The correct form for several basic stretches is shown at the right. Move slowly as you stretch—never bounce.

### 1. Toe Touch Stretch

Stand with your knees bent slightly and slowly bend forward from your hips. Allow your back and shoulders to relax as you reach down toward your toes as far as possible. Hold for 15 counts, then relax. Repeat 3 times. Stretches: Hamstrings, back of knees and back.

### 2. Hamstring Stretch

Sit with one leg extended. Bring the sole of the opposite foot toward you and rest it against the inner thigh of your extended leg. Reach toward your toes as far as possible. Hold for 15 counts, then relax. Repeat 3 times for each leg. Stretches: Hamstrings, lower back and groin.

### 3. Calf/Achilles Stretch

With one leg in front of the other, reach forward and place your hands against a wall. Keep your back leg straight and your back foot flat on the floor. Bend your front leg, lean forward and move your hips toward the wall. Hold for 15 counts, then relax. Repeat 3 times for each leg. To cause further stretching of the achilles tendons, bend your back leg as well. Stretches: Calves, achilles tendons and ankles.

### 4. Quadriceps Stretch

With one hand against a wall for balance, reach back and grasp one foot with your other hand. Bring your heel as close to your buttocks as possible. Hold for 15 counts, then relax. Repeat 3 times for each leg. Stretches: Quadriceps and hip muscles.

### 5. Inner Thigh Stretch

Sit with the soles of your feet together and your knees outward. Pull your feet toward your groin area as far as possible. Hold for 15 counts, then relax. Repeat 3 times. Stretches: Quadriceps and hip muscles.

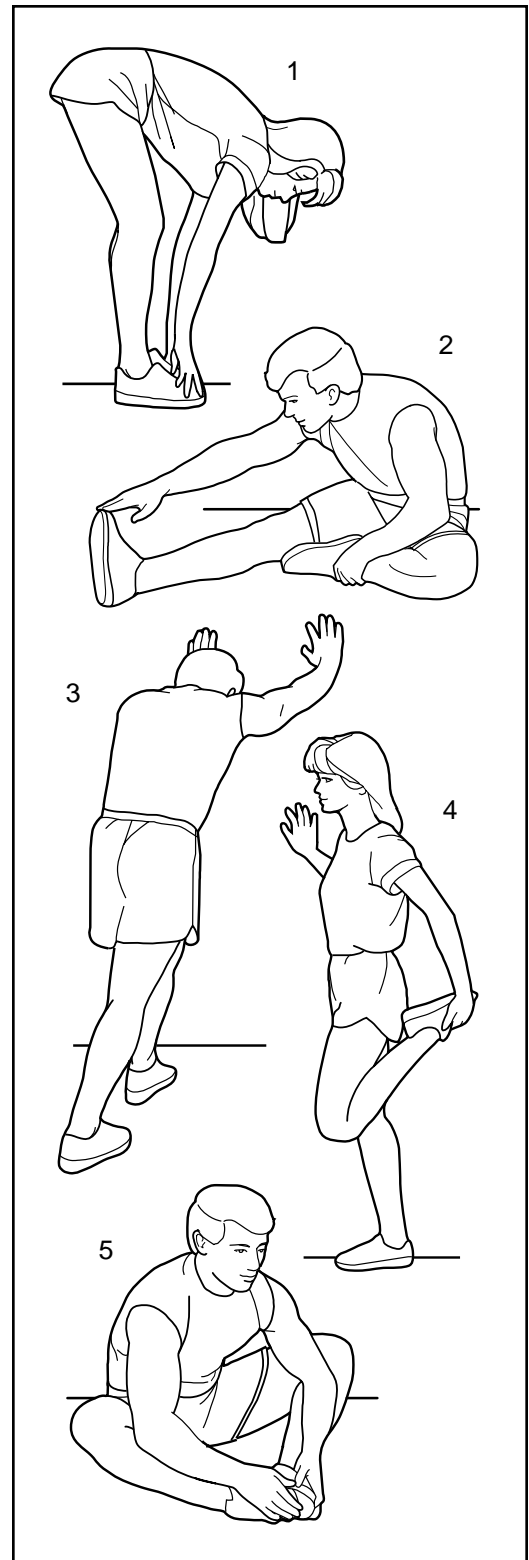

# PART LIST—Model No. HCTL05910

R0801A

To locate the parts listed below, refer to the EXPLODED DRAWING attached in the center of this manual.

Key No.	Qty.	Description	Key No.	Qty.	Description
1	1	Motor Hood	51	1	Frame
2	4	Hood Screw	52	2	Rear Wheel
3	6	Platform Screw	53	2	Rear Wheel Bolt
4	3	Roller Adjustment Washer	54	2	Rear Roller Guard
5	1	Latch Catch	55	2	Rear Wheel Nut
6	6	Latch Catch Screw/Hand Grip Screw	56	1	Rear Roller
7	4	Isolator	57	1	Right Endcap
8	2	Power Bracket Washer	58	1	iFIT.com Videocassette
9	2	Belt Guide	59	2	Rear Roller Adj.Bolt
10	2	Frame Pivot Bolt	60	1	Left Endcap
11	1	Front Roller/Pulley	61	1	Allen Wrench
12	2	Incline Motor Spacer	62	1	Walking Platform
13	2	Incline Motor Bolt	63	2	Handrail Grip
14	2	Incline Motor Nut	64	1	Stop Bracket
15	1	Incline Motor	65	2	Crossbar Bolt
16	4	Lift Frame Bushing	66	2	Crossbar Washer
17	1	Pulse Mounting Plate	67	1	Latch Knob
18	1	Front Roller Adj. Bolt	68	1	Latch Knob Sleeve
19	2	Side Hood Tab	69	1	Latch Spring
20	21	Utility Screw	70	1	Latch Knob Collar
21	2	Wheel Spacer	71	1	Pin Clip
22	1	Front Hood Tab	72	1	Latch Pin
23	1	Reed Switch Clip	73	1	Pulse Bar
24	1	Motor	74	3	Console Base Screw
25	1	2-lb. Hand Weight	75	1	Console Base Cover
26	1	Reed Switch	76	8	Cover Screw
27	1	Motor Belt	77	1	Pulse Sensor Cover
28	1	Pulley/Flywheel/Fan	78	2	Sensor Cover Screw
29	1	Motor Tension Bolt	79	1	Key/Clip
30	2	Motor Tension Washer	80	1	Console Base
31	1	Motor Star Washer	81	1	Book Holder Lens
32	1	Motor Tension Nut	82	1	Console
33	1	Motor Pivot Bolt	83	1	Lift Frame
34*	1	Motor/Pulley/Flywheel/Fan	84	1	Releasable Tie
35	16	Screw	85	1	Magnet
36	1	Choke	86	1	Cable Tie Clamp
37**	1	Chest Pulse Sensor	87	1	8" Power Wire
38	1	Circuit Breaker	88	1	8" Cable Tie
39	1	On/Off Switch	89	1	Jack
40	1	Power Cord	90	1	iFIT.com Wire
41	1	Power Cord Grommet	91	2	Console Screw
42	1	Outlet Bracket	92	2	Endcap Spacer
43	1	Controller	93	7	Lift Frame Nut/Wheel Nut
44	1	Power Supply	94	5	Base Pad
45	4	Plastic Stand-Off	95	1	Left Foot Grip
46	1	Electronics Bracket	96	2	Upright Base Cap
47	1	Belly Pan	97	3	Warning Decal
48	1	Upright Wire Harness	98	2	Wheel Bolt
49	1	Right Foot Grip	99	2	Wheel
50	1	Walking Belt	100	2	Wheel Insert

Key No.	Qty.	Description
101	1	12" Audio Wire
102	1	Large Warning Decal
103	1	Upright/Base
104	1	Shock
105	2	Lift Frame Spacer
106	2	Static Decal
107	1	Latch Assembly
108	1	iFIT.com CD
#	1	8" Green Wire, F/Ring
#	1	7" Green Wire, M/Ring
#	1	4" Black Wire, 2 Female
#	1	8" White Wire, 2 Female
#	1	8" Red Wire, M/F
#	1	8" Blue Wire, M/F

Key No.	Qty.	Description
#	1	8" Black Wire, 2 Ring
#	1	4" Blue Wire, 2 Female
#	1	8" White Wire, M/F
#	1	14" Blue Wire, 2 Female
#	1	User's Manual

\*Includes all parts shown in the box.

\*\*For information about the optional chest pulse sensor, see page 20.

#These parts are not illustrated

Specifications are subject to change without notice.

# HOW TO ORDER REPLACEMENT PARTS

To order replacement parts, call our Customer Service Department toll-free at 1-888-936-4266, Monday through Friday, 8h00 to 18h30, Eastern Standard Time (excluding holidays). Before calling, please note the following information:

- the MODEL NUMBER of the product (HCTL05910)
- the NAME of the product (HealthRider® Softstrider S300i™ treadmill)
- the SERIAL NUMBER of the product (see the front cover of this manual)
- the KEY NUMBER and DESCRIPTION of the replacement part(s) (see the PART LIST on pages 26 and 27 and the EXPLODED DRAWING attached in the center of this manual).

## LIMITED WARRANTY

ICON OF CANADA INC., (ICON), warrants this product to be free from defects in workmanship and material, under normal use and service conditions, for a period of one year from the date of purchase. This warranty extends only to the original purchaser. ICON's obligation under this warranty is limited to replacing or repairing, at ICON's option, the product at one of its authorized service centers. All products for which warranty claim is made must be received by ICON at one of its authorized service centers with all freight and other transportation charges prepaid, accompanied by sufficient proof of purchase. All returns must be pre-authorized by ICON. This warranty does not extend to any product or damage to a product caused by or attributable to freight damage, abuse, misuse, improper or abnormal usage or repairs not provided by an ICON authorized service center, to products used for commercial or rental purposes, or to products used as store display models. No other warranty beyond that specifically set forth above is authorized by ICON.

ICON is not responsible or liable for indirect, special or consequential damages arising out of or in connection with the use or performance of the product or damages with respect to any economic loss, loss of property, loss of revenues or profits, loss of enjoyment or use, costs of removal, installation or other consequential damages of whatsoever nature. Some provinces do not allow the exclusion or limitation of incidental or consequential damages. Accordingly, the above limitation may not apply to you. The warranty extended hereunder is in lieu of any and all other warranties and any implied warranties of merchantability or fitness for a particular purpose is limited in its scope and duration to the terms set forth herein. Some provinces do not allow limitations on how long an implied warranty lasts. Accordingly, the above limitation may not apply to you.

This warranty gives you specific legal rights. You may also have other rights which vary from province to province or so specified by the retailer of your equipment.

**ICON OF CANADA, INC., 900 de l'Industrie, St. Jérôme, QC J7Y 4B8**

# EXPLODED DRAWING—Model No. HCTL05910

R0801A

**REMOVE AND SAVE THIS EXPLODED DRAWING FOR FUTURE REFERENCE.**

To identify the parts shown on this exploded drawing, refer to the PART LIST on pages 26 and 27 of the USER'S MANUAL.

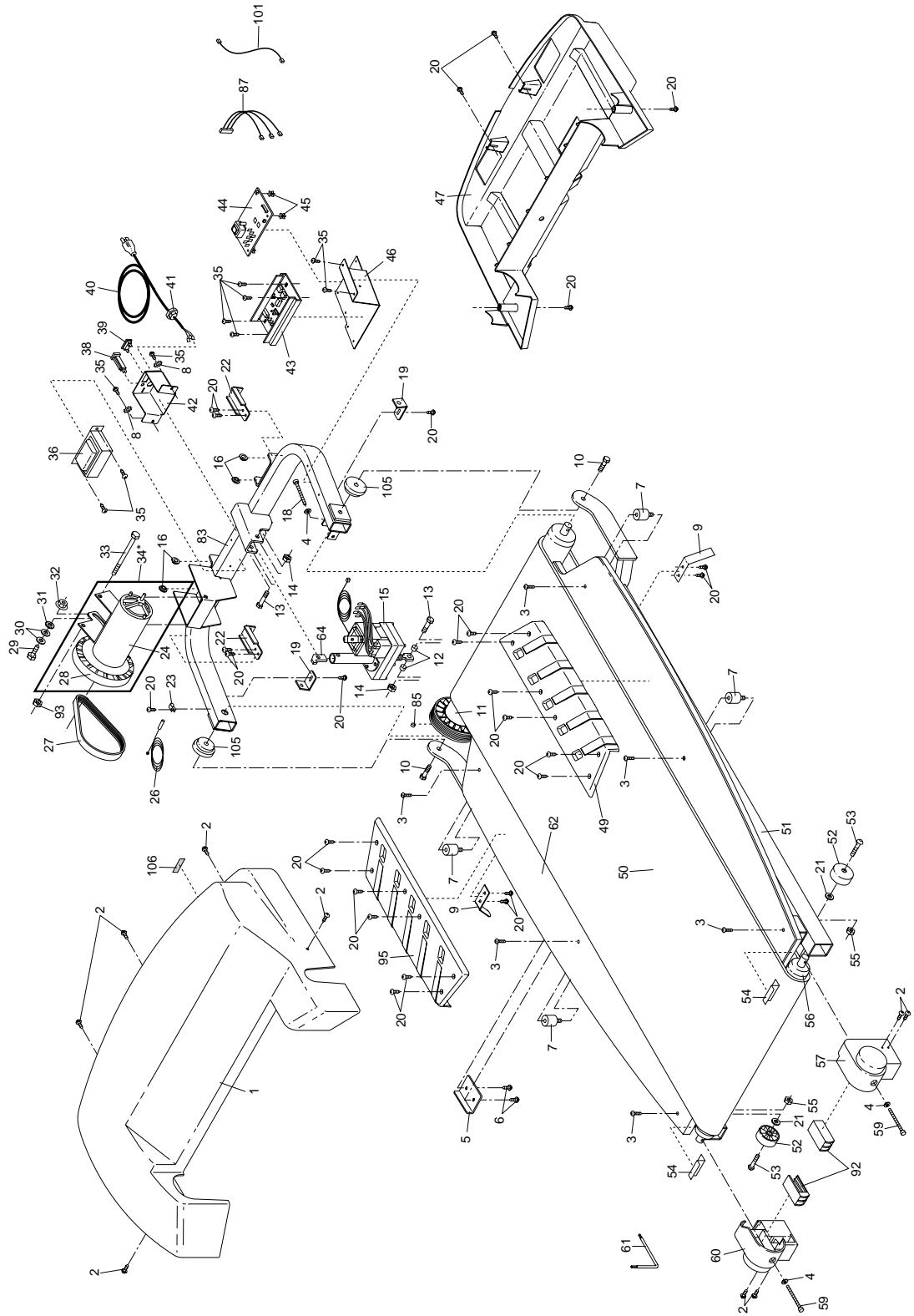

# EXPLODED DRAWING—Model No. HCTL05910

R0801A

